

A	
B	
C	
D	
E	
L	
L1	
L2	
T	

<p>This drawing is sent to you subject to return upon demand and with the understanding that it is not to be reproduced copied or used directly or indirectly in any way detrimental to our interests.</p>	
<p>Drawn By: Mr B. A. White</p>	<p>Customer:</p>
<p>Date: 24/01/2013</p>	<p>DRG No.:</p>
<p>Title: Lifer Sample No.1</p>	

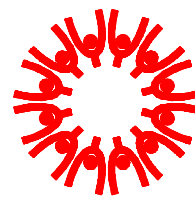

Leyletts Ltd

ENGINEERING CO.

Corwallis Road
West Bromwich
West Midlands
B70 7JF

Tel: 0944 (0)121 544888

Web Site: www.quarryandrecycling.co.uk

Fax: 0944 (0)121 544883

E-mail: info@leyletts.co.uk

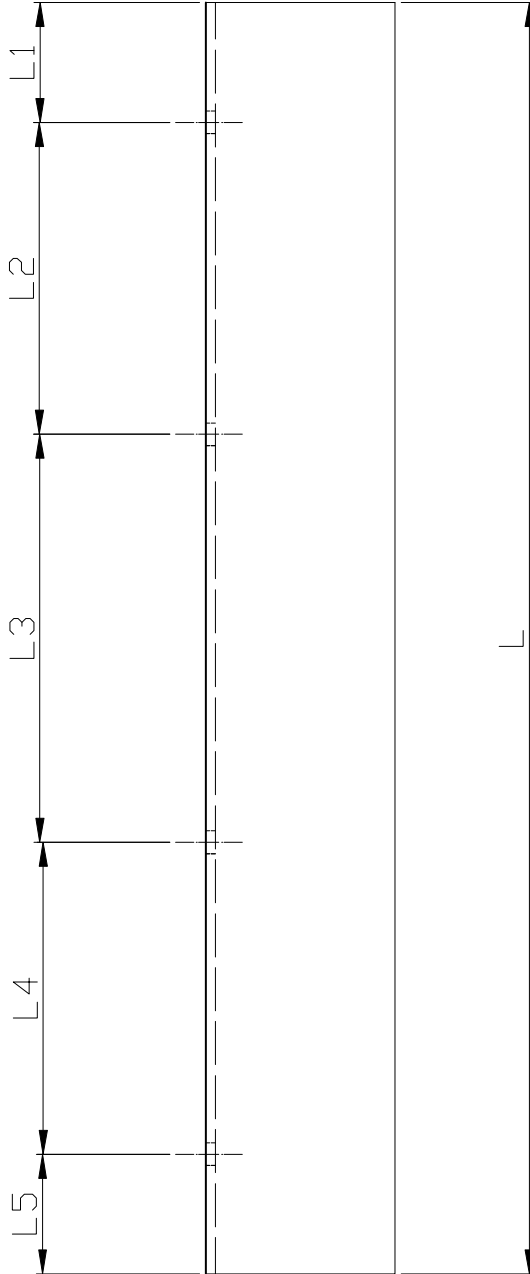
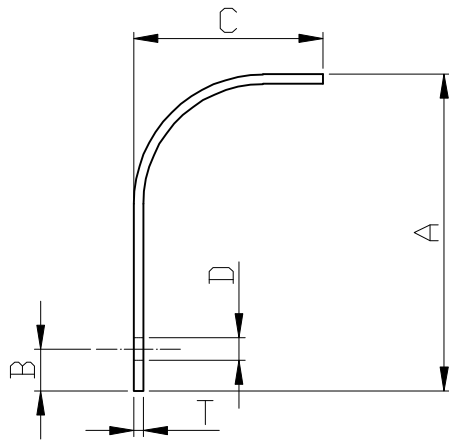

A	
B	
C	
D	
L	
L1	
L2	
L3	
L4	
L5	
T	

This drawing is sent to you subject to return upon demand and with the understanding that it is not to be reproduced copied or used directly or indirectly in any way detrimental to our interests.

Drawn By: Mr B. A. Willetts

Customer:

Date: 24/01/2013

DRG No:

Title: Lifter Sample No.2

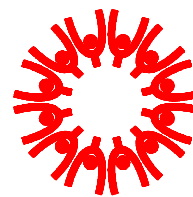

Leyletts Ltd

ENGINEERING CO.

Corwallis Road
West Bromwich
West Midlands
B70 7JF

Tel: 0944 (0)121 544888

Fax: 0944 (0)121 544883

Web Site: www.quarryandrecycling.co.uk

E-mail: info@leyletts.co.uk

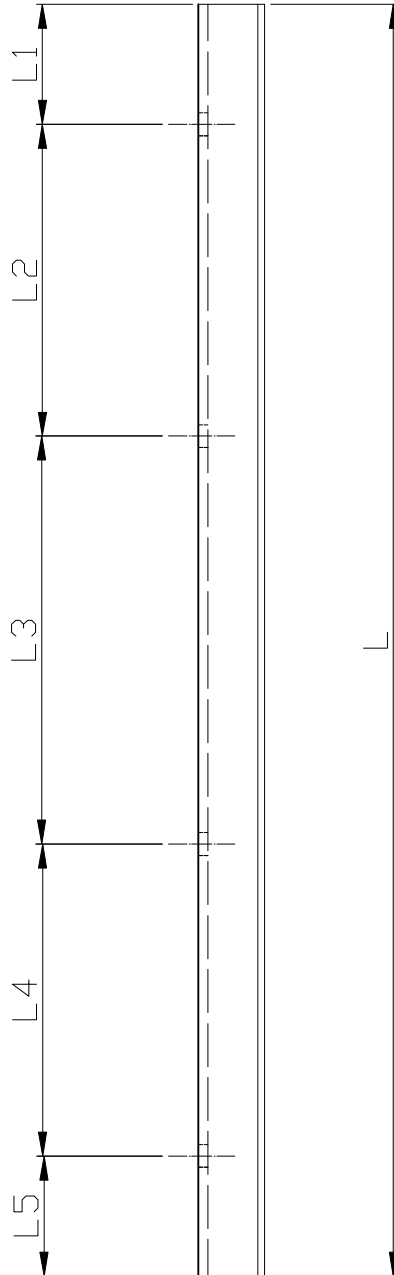
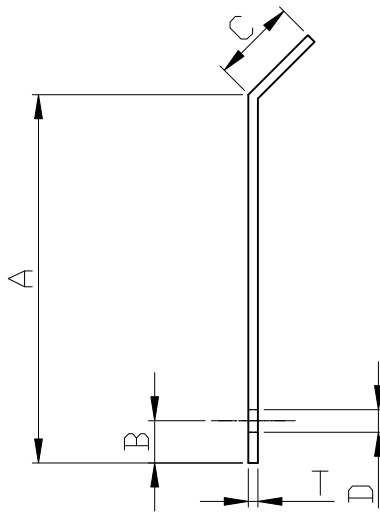

A	
B	
C	
D	
L	
L1	
L2	
L3	
L4	
L5	
T	

This drawing is sent to you subject to return upon demand and with the understanding that it is not to be reproduced copied or used directly or indirectly in any way detrimental to our interests.

Drawn By: Mr B. A. Willets

Customer:

Date: 24/01/2013

DRG No.:

Title: Lifter Sample No.3

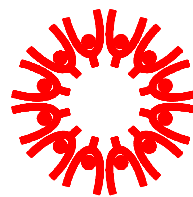

Leyletts Ltd

ENGINEERING CO.

Corwallis Road
West Bromwich
West Midlands
B70 7JF

Tel: 0944 (0)121 544888

Fax: 0944 (0)121 544883

Web Site: www.quarryandrecycling.co.uk

E-mail: info@leyletts.co.uk

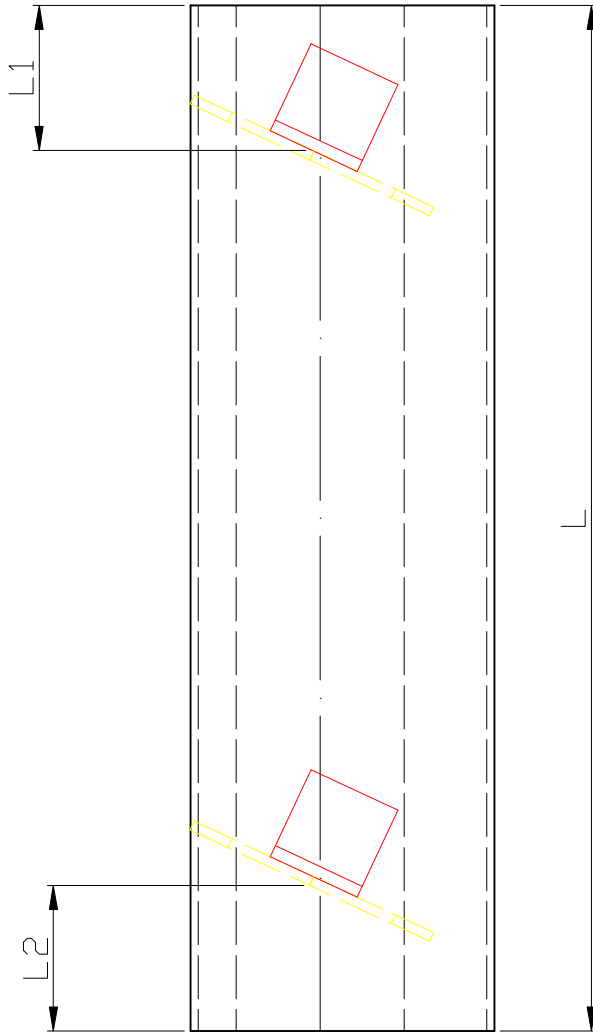
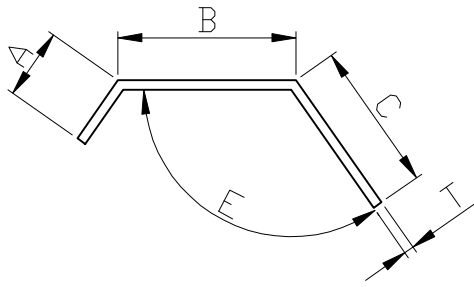

A	
B	
C	
D	
E	
F	
G	
H	
L	
L1	
L2	
T	
T2	

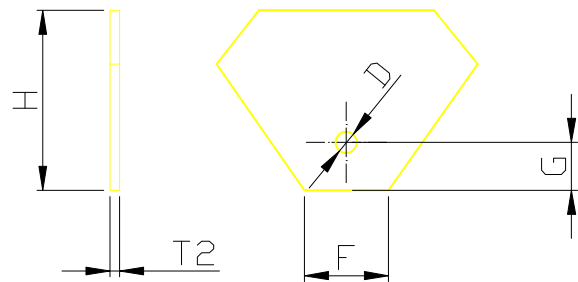

<p>This drawing is sent to you subject to return upon demand and with the understanding that it is not to be reproduced copied or used directly or indirectly in any way detrimental to our interests.</p>	
<p>Drawn By: Mr B. A. Willets</p>	<p>Customer:</p>
<p>Date: 24/01/2013</p>	<p>DRG No.:</p>
<p>Title: Lifter Sample No.4</p>	

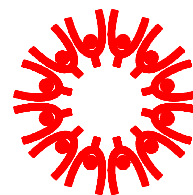

Leyletts Ltd

ENGINEERING CO.

Corwallis Road
West Bromwich
West Midlands
B70 7JF

Tel 0944 (0)121 544888

Web Site www.quarryandrecycling.co.uk

Fax 0944 (0)121 544883

E-mail info@leyletts.co.uk

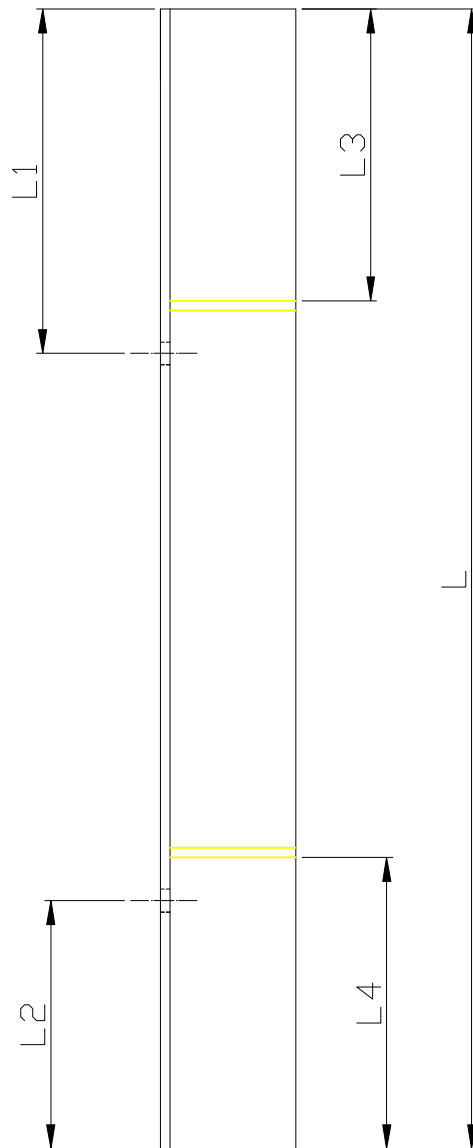
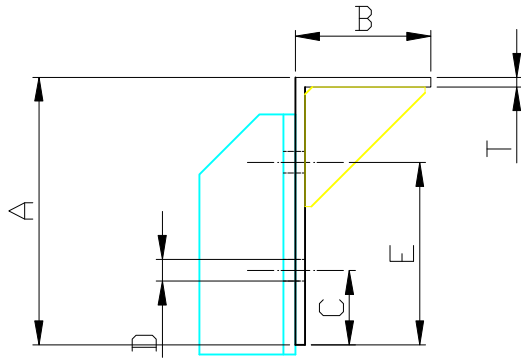

A	
B	
C	
D	
E	
F	
G	
L	
L1	
L2	
L3	
L4	
T	
T2	

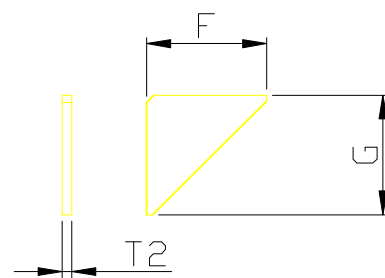

This drawing is sent to you subject to return upon demand and with the understanding that it is not to be reproduced copied or used directly or indirectly in any way detrimental to our interests.

Drawn By: Mr B. A. Willets

Customer:

Date: 24/01/2013

DRG No.:

Title: Lifter Sample No.5

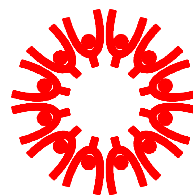

Leyletts Ltd

ENGINEERING CO.

Cornwall Road
West Bromwich
West Midlands
B70 7JF

Tel 0944 (0)121 544888

Fax 0944 (0)121 544883

Web Site www.quarryandrecycling.co.uk

E-mail info@leyletts.co.uk

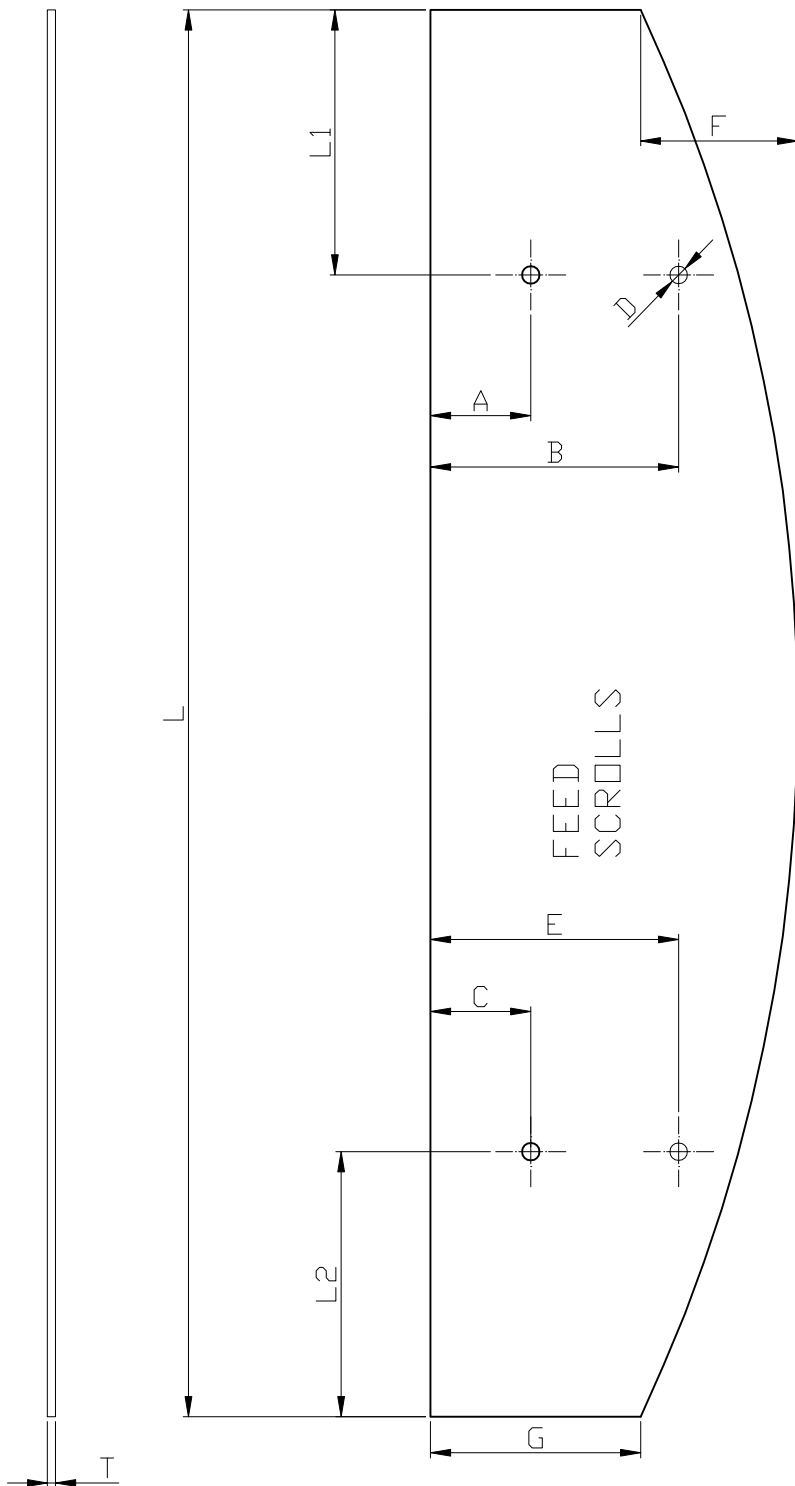

FEED
SCROLLS

A	
B	
C	
D	
E	
F	
G	
L	
L1	
L2	
T	

<p>This drawing is sent to you subject to return upon demand and with the understanding that it is not to be reproduced copied or used directly or indirectly in any way detrimental to our interests.</p>	
<p>Drawn By: Mr B. A. Willetts</p>	<p>Customer:</p>
<p>Date: 24/01/2013</p>	<p>DRG No.:</p>
<p>Title: Lifer Sample No.6</p>	

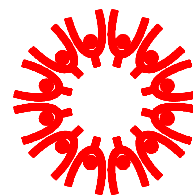

Leyletts Ltd

ENGINEERING CO.

Cornwall Road
West Bromwich
West Midlands
B70 7JF

Tel 0944 (0)121 544888

Fax 0944 (0)121 544883

Web Site www.quarryandrecycling.co.uk

E-mail info@leyletts.co.uk

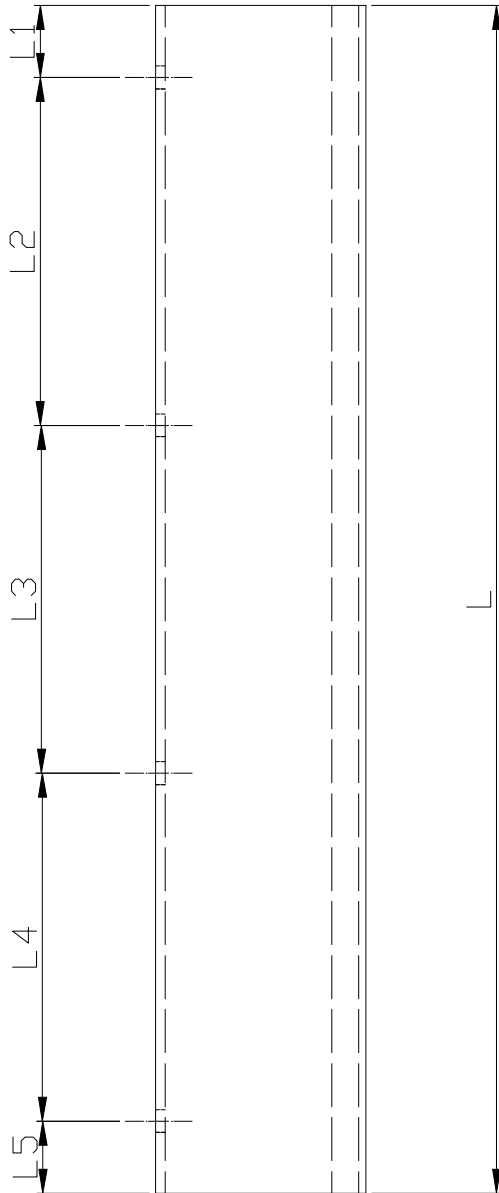
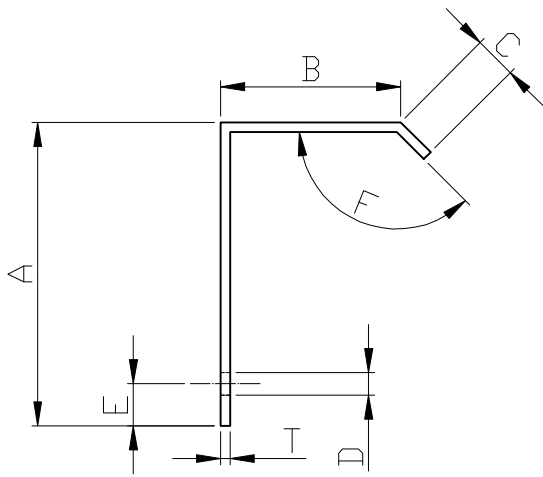

A	
B	
C	
D	
E	
F	
L	
L1	
L2	
L3	
L4	
L5	
T	

This drawing is sent to you subject to return upon demand and with the understanding that it is not to be reproduced copied or used directly or indirectly in any way detrimental to our interests.

Drawn By: Mr B. A. Willetts

Customer:

Date: 24/01/2013

DRG No.:

Title: Lifter Sample No.7

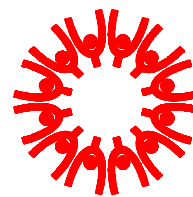

Leyletts Ltd

ENGINEERING CO.

Corwallis Road
West Bromwich
West Midlands
B70 7JF

Tel 0944 (0)121 544888

Fax 0944 (0)121 544883

Web Site: www.garryandrecycling.co.uk

E-mail: info@leyletts.co.uk

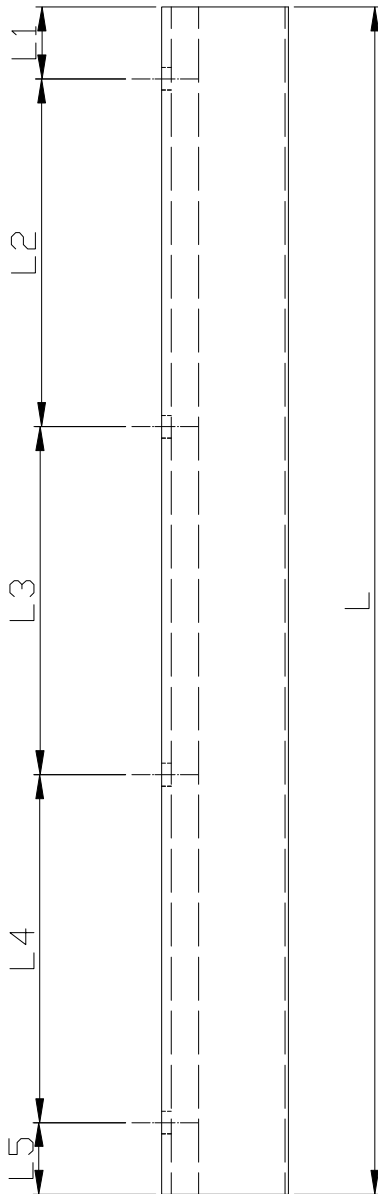
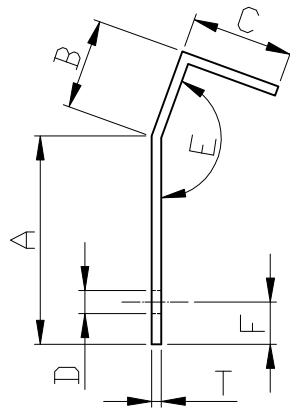

A	
B	
C	
D	
E	
F	
L	
L1	
L2	
L3	
L4	
L5	
T	

This drawing is sent to you subject to return upon demand and with the understanding that it is not to be reproduced copied or used directly or indirectly in any way detrimental to our interests.

Drawn By: Mr B. A. Willets

Customer:

Date: 24/01/2013

DRG No.:

Title: Lifter Sample No.8

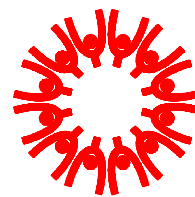

Leyletts Ltd

ENGINEERING CO.

Corwallis Road
West Bromwich
West Midlands
B70 7JF

Tel 0944 (0)121 544888

Fax 0944 (0)121 544883

Web Site: www.quarryandrecycling.co.uk

E-mail: info@leyletts.co.uk

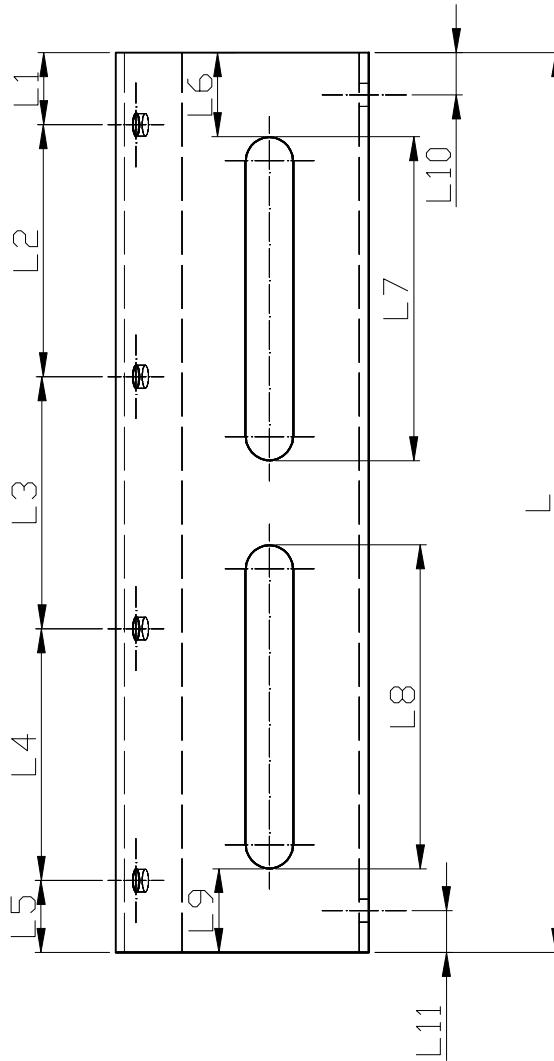
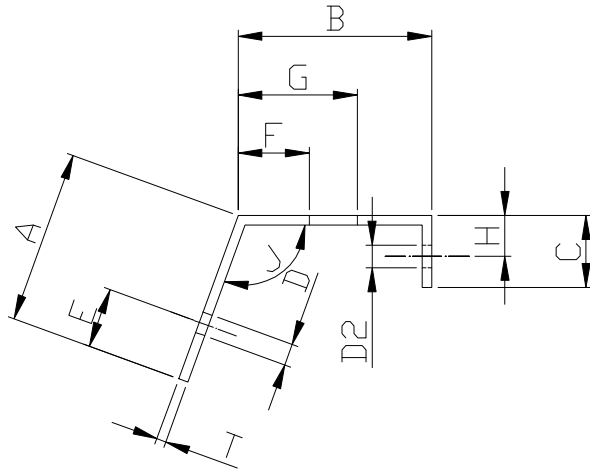

A	
B	
C	
D	
D2	
E	
F	
G	
H	
J	
L	
L1	
L2	
L3	
L4	
L5	
L6	
L7	
L8	
L9	
L10	
L11	
T	

This drawing is sent to you subject to return upon demand and with the understanding that it is not to be reproduced copied or used directly or indirectly in any way detrimental to our interests.

Drawn By: Mr B. A. Willetts

Customer:

Date: 24/01/2013

DRG No.:

Title: Lifter Sample No.9

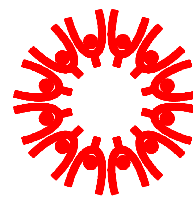

Leyletts Ltd

ENGINEERING CO.

Corwallis Road
West Bromwich
West Midlands
B70 7JF

Tel 0944 (0)121 544888

Fax 0944 (0)121 544883

Web Site: www.quarryandrecycling.co.uk

E-mail: info@leyletts.co.uk

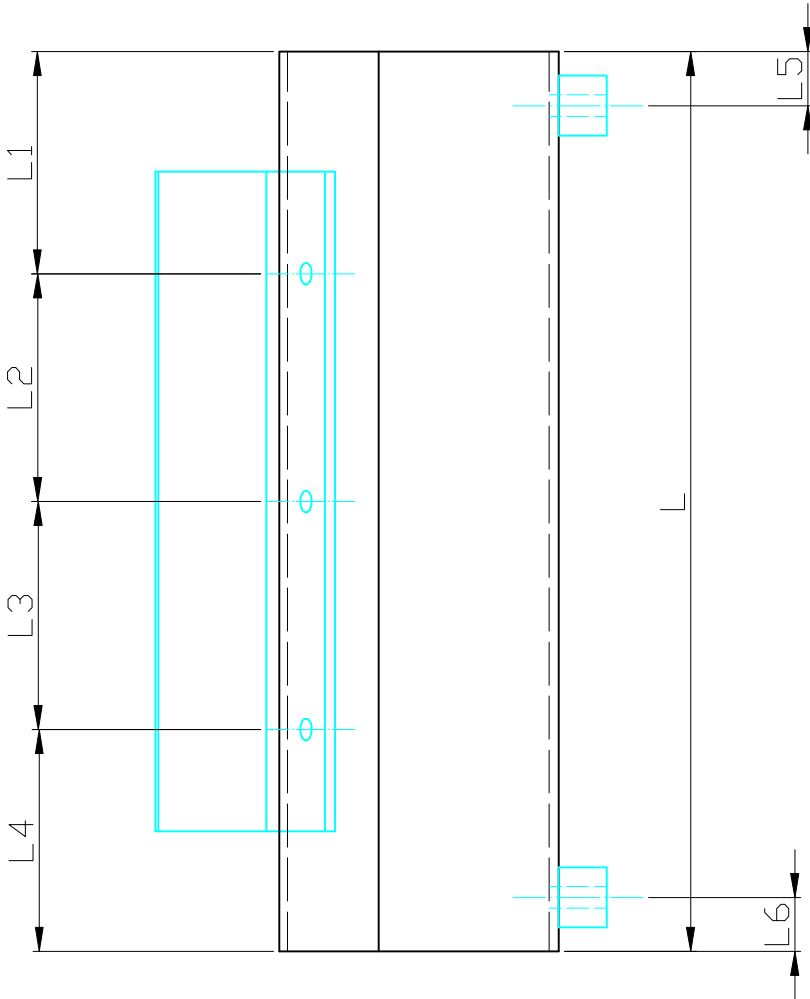
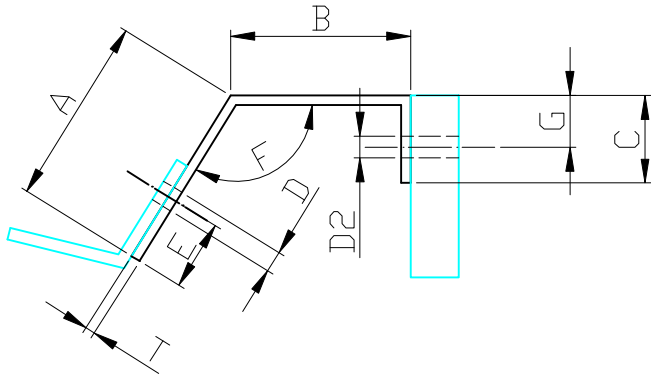

A	
B	
C	
D	
D2	
E	
F	
G	
L	
L1	
L2	
L3	
L4	
L5	
L6	
T	

<p>This drawing is sent to you subject to return upon demand and with the understanding that it is not to be reproduced copied or used directly or indirectly in any way detrimental to our interests.</p>	
<p>Drawn By: Mr B. A. Willetts</p>	<p>Customer:</p>
<p>Date: 24/01/2013</p>	<p>DRG No.:</p>
<p>Title: Lifter Sample No.10</p>	

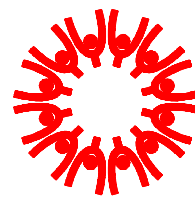

Leyletts Ltd

ENGINEERING CO.

Corwallis Road
West Bromwich
West Midlands
B70 7JF

Tel 0944 (0)121 544888

Fax 0944 (0)121 544883

Web Site www.quarryandrecycling.co.uk

E-mail info@leyletts.co.uk

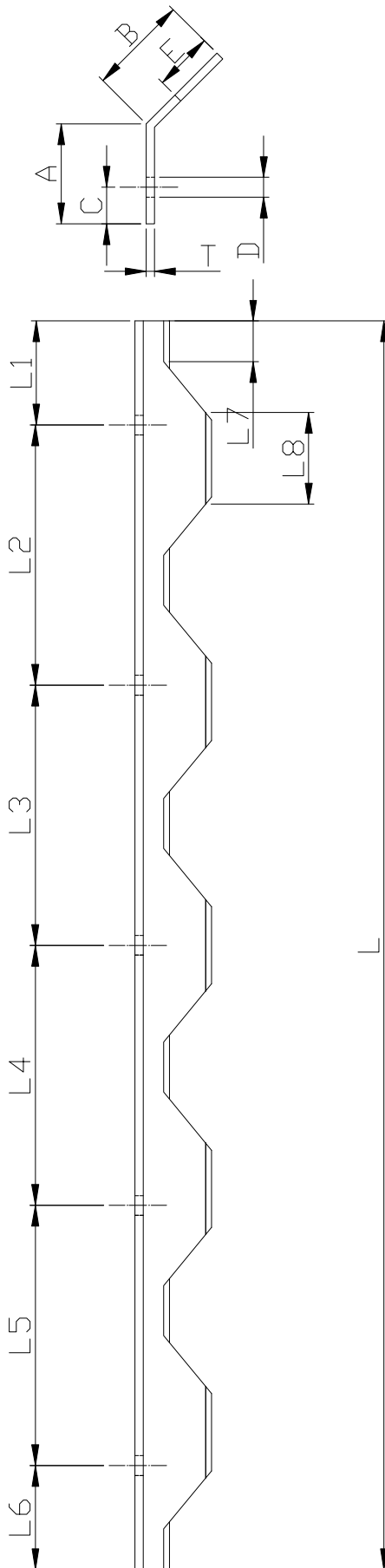

A	
B	
C	
D	
E	
L	
L1	
L2	
L3	
L4	
L5	
L6	
L7	
L8	
T	

This drawing is sent to you subject to return upon demand and with the understanding that it is not to be reproduced copied or used directly or indirectly in any way detrimental to our interests.

Drawn By: Mr B. A. Willets

Customer:

Date: 24/01/2013

DRG No.:

Title: Lifter Sample No.11

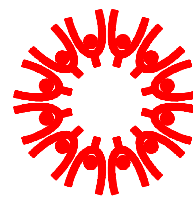

Leyletts Ltd

ENGINEERING CO.

Cornewalls Road
West Bromwich
West Midlands
B70 7JF

Tel 0944 (0)121 544888

Fax 0944 (0)121 544883

Web Site www.garryandrecycling.co.uk

E-mail info@leyletts.co.uk